

kubiq™
Kitchens Your Way
酷优品 櫥配

The modular
kitchen system for everyone

Self
Involvement
Concept

Kitchen | Wardrobe | Appliances | Accessories

www.kubiq.com.my

◆ About the company

Kubiq was incorporated with the objective to offer quality yet affordable modular kitchen systems in response to the growing demand in the mass market segment, which represents a huge market share in the kitchen systems industry. Coupled with customers' increased price sensitivity and emphasis on product value, the Kubiq brand aims to meet the needs of a fast-expanding yet discerning customer base. Kubiq is a wholly owned subsidiary of Signature International Berhad, a public-listed company behind the well-known SignatureKitchen brand founded in 1994.

Through its groundbreaking and innovative approach, Kubiq has introduced a new and creative kitchen planning experience through a "self-involvement" concept which gives maximum flexibility in every step – from hands-on design, planning, coordination of delivery and the final installation. This no-frills approach helps to keep costs low and put control back in the hands of the customer, much in the same way low cost airlines operate.



“ With Kubiq, everyone can now afford and own a quality kitchen system that suits their lifestyle, budget and preferences! ”



Kubiq Sdn. Bhd.

Lot 2, Jalan Teknologi 3/7, Taman Sains Selangor 1,
Kota Damansara, PJU 5, 47810 Petaling Jaya, Selangor, Malaysia.
Tel: +603-6148 8929 Fax: +603-6286 7101

www.kubiq.com.my

◆ Why buy Kubiq



LOW PRICE

- Kubiq operates on **low overheads** which come from low rental, no designer salaries, no sales commissions and no project management costs. All these translate to **huge savings** which are passed down to you through our amazingly low prices.
- Through our **bulk purchases and mass production** you benefit from economies of scale compared to custom-made orders – resulting in an **extremely cost-effective solution**.



NO FRILLS

- You only **pay for the price of the product**, with the option of having other value-added services at a nominal cost.
- Our modular kitchen systems have been designed from our years of experience to suit a wide variety of needs, and complement each other perfectly. This allows you to **tailor your choice and pay only for the components you want**.
- A transparent and detailed component price list enables you to **manage your own budget without hidden costs and fees**.



WAIT NO MORE

- Kubiq's **ezikit**, the patented 3D kitchen miniature modeling kit – our very own interactive design and quotation tool – you can **complete the design and obtain a quotation within a few minutes** without having to come back on another day.
- Most of your choices are in stock, you can usually take home your purchase within the same day once payment is made. You even control and manage your own delivery and installation schedule.



TRUSTED QUALITY

- Kubiq products come from the same sources as Malaysia's leading kitchen manufacturer with nearly **two decades of industry experience and backed by a publicly listed parent company**.



◆ At Kubiq, we let you be in charge!

Kubiq's no-frills approach is your best cost saving choice.

Did you know that you are open to all these choices and you can save so much in your kitchen cabinet and wardrobe purchase?

✓ 1) **Kitchen design and plan**

Kubiq's *ezikit* is the world's simplest kitchen planning kit for anyone.

✓ 2) **Buy practical kitchen components**

You know exactly the price of each component, so you can cross out what is not necessary!



✓ 3) **Pick the items you need**

We are transparent to let you know the cost of each item. So, pick according to your budget!

✓ 4) **Choose your services**

We even let you drive the goods home for even more savings.

✓ 5) **You make the CALL!**

The final step is the installation arrangement. You just need to call them to book an installation date!

You can take charge of the final outcome, paying only for what you need and not for what you don't.



◆ Why pay someone to do it when you can do it yourself?



Kubiq's self-involvement concept allows you to be involved in the entire buying process from planning, design, delivery and installation. This way, you can take charge of the final outcome, paying only for what you need and not what you don't.

Your involvement has eliminated the overhead cost for designer and kitchen consultant, and savings are passed on to you through our fabulously lower prices.

With Kubiq, you can actually enjoy the experience of completing your own kitchen in the exact way you want. You can now give your home the quality look that it deserves with a price tag that doesn't cost an arm or a leg.

5 EASY STEPS TO GET YOUR KITCHEN DONE!



Visit Kubiq to find out the easy way to get your kitchen design and quotation instantly.



Use the ezikit, a patented 3D kitchen miniature modeling kit; with this, you can design your own kitchen and enjoy the fun experience like never before.



After completed your design, our advance computer scanning process will generate quotation instantly from the 3D miniature modeling.



Select your choice of material and you can now make your order **within the same day**.



Coordinate with 3rd party transporter and installer to get your kitchen delivered and installed.



Your kitchen is now completed.

◆ Plan and design your kitchen in 3 easy steps.

STEP 1 - MEASURE ACCURATELY

Measure your room accurately allowing the existing fixtures such as doors and windows as well as any specifications for your appliances.

You will need: Measuring tape / Pencil / Pen / Calculator

STEP 2 - SELECT YOUR LAYOUT

Start by considering your current layout and what you like and dislike. A functional kitchen often centres on the position of the sink, oven/cooktop and refrigerator. To maximise functionality, it is ideal to position these in an imaginary triangle with a minimum of 1.2m between each workstation.

Choose one of the following layout templates to start your design:

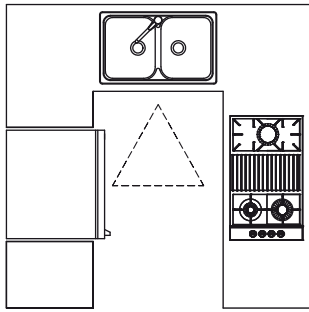

◆ U-Shape

The U-Shape design has become a popular choice for kitchen layouts. It is most commonly suited to larger kitchen spaces and is a perfect layout for families who spend a great deal of time in the kitchen. Providing efficiency and functionality, the U-shape design also offers maximum cabinet and benchtop space.

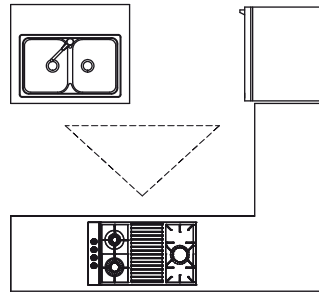

◆ L-Shape with Island

The L-Shape with island design has all the qualities of the standard L-shape layout however provides an additional workstation within the kitchen area. An island benchtop in this format is most suited to larger, more spacious kitchens. Additional cabinets and benchtop work space also makes this kitchen family friendly and an entertainer's paradise.

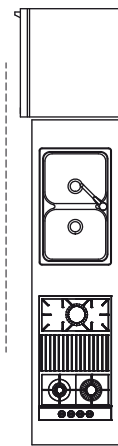

◆ I-Shape

The I-Shape kitchen is ideal for small and narrow kitchen areas however can also comfortably accommodate larger kitchens. The I-shape is a simple kitchen design and is often the most inexpensive in relation to other kitchen layouts.

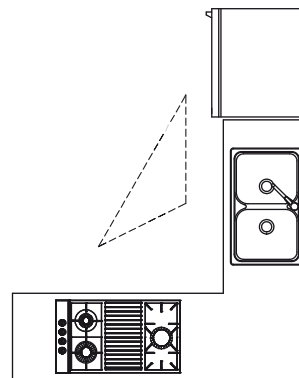

◆ L-Shape

The L-Shape kitchen can be suited to open plan living areas, smaller areas, and long rooms and is a very popular choice. This design enables you to move freely between the various areas within the kitchen and can provide you with great benchtop working space.

STEP 3 - PLAN YOUR KITCHEN

Once you have decided on the basic layout of your kitchen you can begin to plan position your kitchen cabinets by using our ezikit planning tools.

For more information on planning and designing including kitchen layout tips and suggestions visit www.kubiq.com.my

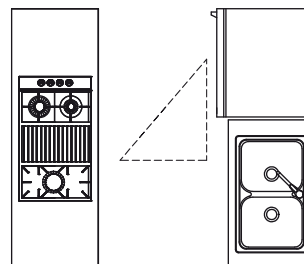

◆ Galley

The Galley style kitchen is a functional design that allow you to reach all areas of the kitchen with minimal walking distance. Providing a great layout for ample cabinets and benchtop space, the Galley style kitchen is a modern and contemporary kitchen design and the choice of many chefs.

◆ How to design your ideal kitchen **with ezikit?**

Kubiq puts kitchen design into your own hands...literally! **ezikit** is our patented 3D kitchen miniature modeling kit. It is a miniature version of your kitchen, that you can arrange and rearrange until you find the perfect fit for your requirement. Think of a jigsaw puzzle that helps you plan and visualize your actual kitchen in a smaller scale.



Arrange the miniature cabinets to form your preferred design layout.



Once you are satisfied, just take a photo of the design layout for your reference.



Scan the module to obtain the quotation in an itemized detailed list and a transparent cost.



◆ Modular Kitchen Systems

Our kitchen systems have been designed from our years of experience to suit a wide variety of needs and for different kitchen space.



Each module complement each other perfectly with combination of components and accessories that you can add on according to your preferences.

"Kubiq allows you to tailor make choices, paying only for the necessary components you need!"



Material Specification

DOOR: MELAMINE, DL101

WORKTOP: HPL , F125, Jura

GREAT KITCHEN IDEAS are meant for sharing!

In Kubiq, we share a variety of designs that caters to all lifestyle needs. All our modular kitchen systems will fit into your home matching your preferences, because it is done your way!



Material Specification

DOOR: MELAMINE, GD0595

WORKTOP: HPL, F558, Unica Off White

Kubiq offers practical products with great value at prices you can afford. The modular systems are made to fit most tastes, and are flexible and diverse in the options available to cater to everyone. Best of all, Kubiq allows you to be inspired by the different design ideas and enjoy the experience of completing the kitchen the exact way you want with the best cost saving options.



Material Specification

DOOR: MELAMINE, 3A6

WORKTOP: HPL, MM262, Iron Stone

Material Specification

DOOR: SPRAY PAINT, SEASON WHITE

WORKTOP: HPL, F133, Trento Grey-Beige





Material Specification

DOOR: MELAMINE, GD3042

WORKTOP: HPL, W980, Platinum White



Material Specification

DOOR: ACRYLIC, B01

WORKTOP: SOLIDTOP, 1001, White



Material Specification

DOOR: MELAMINE, 3A6

WORKTOP: HPL, MM262, Iron Stone

◆ Kitchen templates



A300
I-SHAPE
3000mm



B150-255
L-SHAPE
1500 x 2550mm



A360
I-SHAPE
3600mm



B150-300
L-SHAPE
1500 x 3000mm



A315
I-SHAPE
3150mm



C150-300-105
U-SHAPE
1500 x 3000 x 1050mm





MIX AND MATCH your wardrobe combinations.

A variety of wardrobe combinations to help you choose your best fit. Understanding your own wardrobe storage needs will eventually save you from paying the unnecessary components. KubiQ's wardrobe modular systems allow you to plan, mix and match your own way!

◆ Wardrobe templates

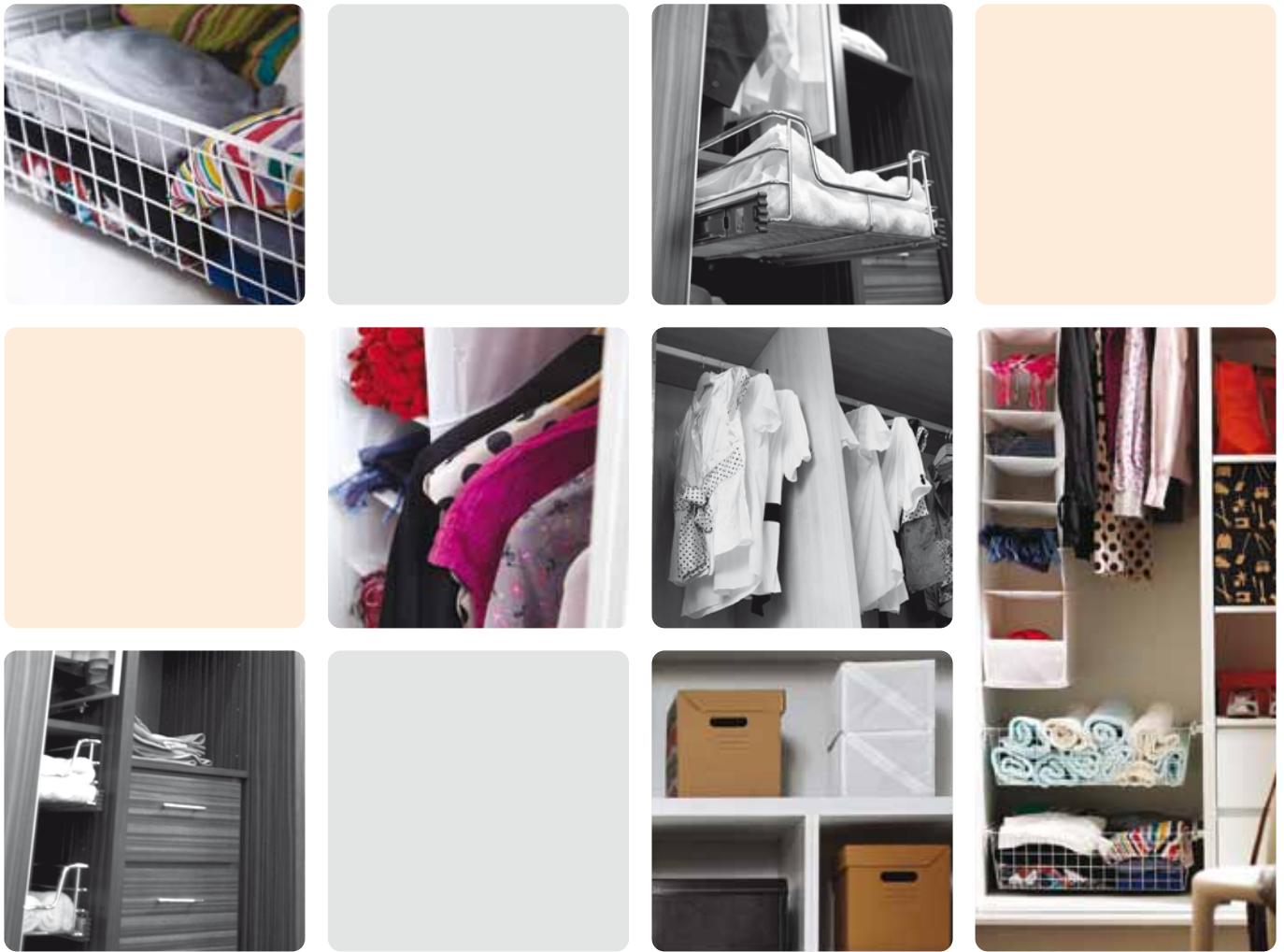

Select Your DOOR STYLE



**SWING SYSTEM
PANEL DOOR**

SD45-90



**SLIDING SYSTEM
PANEL DOOR**

SP120-120



**SLIDING SYSTEM
FROSTED GLASS DOOR**

SG90-90-90



Plan Your FUNCTION



code: SD60-90



code: SD45-45-90



code: SD60-60-90



code: SD60-60-120



code: SP75-75



code: SP45-45-90



code: SP105-60-45



code: SP60-60-120



code: SG75-75



code: SG45-45-90



code: SG105-60-45



code: SG60-60-120



*** Standard Specification:**

- White Carcass.
- Exposed Panel and Internal Drawer are not included.



STYLISH

Modular wardrobe systems can be planned to adapt to your personal style and taste, because it is done your way!

◆ Door material

Group 1 : Melamine ABS Door



D101*



GD0595*



GD6768*



GD3042



GD7284*



2020*



3D1



3A6

* Applicable to wardrobe doors

Group 2 : Spray Painted Door



Season
White

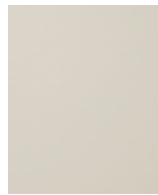

Oyster



Earth Grey

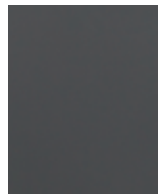

Graphite

Group 2 : UV Gloss Door



UV Gloss
White

Group 3 : Acrylic High Gloss Door

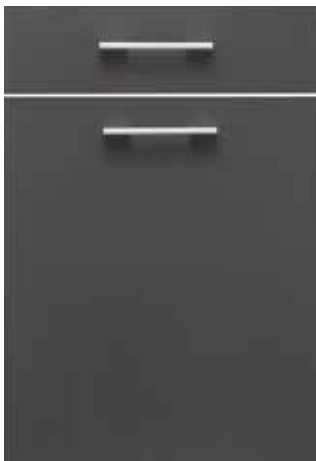

A02



A03



A08



A12

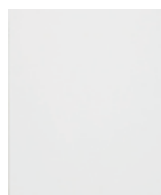

B01



B03



B06



R19



◆ HPL worktop



Jura
F125



Trento Grey-Beige
F133



Unica Off White
F558



Red Brown
Leon Slate
F273

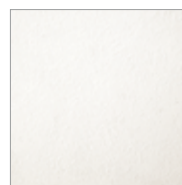

Platinum White
W980

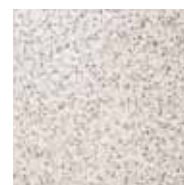

Iron Stone
MM262

Features:

- EUROSPAN® raw chipboard E1 seamlessly laminated with EGGER laminate on flat surfaces and profiles.
- Highly resistant against abrasion, impacts and scratching.
- PUR hot melt adhesive seal on the rear long edge.
- Integrated thin chipboard edging in post-forming applications to optimise surface neutrality and shock resistance.

The standard sheet size is 38 x 600 x 3650mm.

◆ Kitchen module

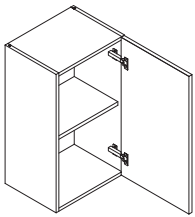

Product Code	Description	Dimensions (W x H x D)
QW3070	Wall Unit, 1 Door, 1 Shelf	300 x 700 x 300mm
QW4070	Wall Unit, 1 Door, 1 Shelf	400 x 700 x 300mm
QW4570	Wall Unit, 1 Door, 1 Shelf	450 x 700 x 300mm
QW5070	Wall Unit, 1 Door, 1 Shelf	500 x 700 x 300mm
QW6070	Wall Unit, 1 Door, 1 Shelf	600 x 700 x 300mm

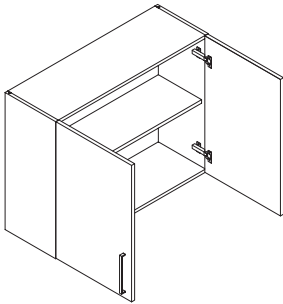

Product Code	Description	Dimensions (W x H x D)
QW8070	Wall Unit, 2 Doors, 1 Shelf	800 x 700 x 300mm
QW9070	Wall Unit, 2 Doors, 1 Shelf	900 x 700 x 300mm

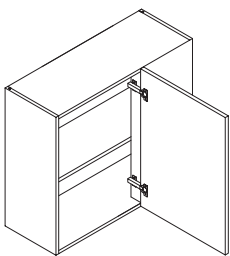

Product Code	Description	Dimensions (W x H x D)
QWC6070	Wall Corner Unit, 1 Door (300mm), 1 Shelf	600 x 700 x 300mm
QWC7570	Wall Corner Unit, 1 Door (450mm), 1 Shelf	750 x 700 x 300mm
QWC9070	Wall Corner Unit, 1 Door (600mm), 1 Shelf	900 x 700 x 300mm

Remarks : Include 1 Infill

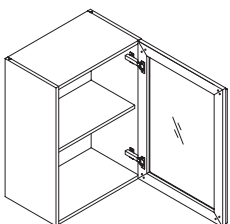

Product Code	Description	Dimensions (W x H x D)
QWAG4570	Wall Unit, 1 Glass Door, 1 Shelf	450 x 700 x 300mm
QWAG6070	Wall Unit, 1 Glass Door, 1 Shelf	600 x 700 x 300mm

◆ Kitchen module

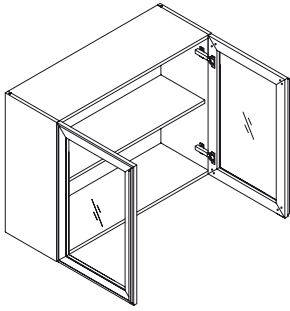

Product Code	Description	Dimensions (W x H x D)
QWAG9070	Wall Unit, 2 Glass Doors, 1 Shelf	900 x 700 x 300mm

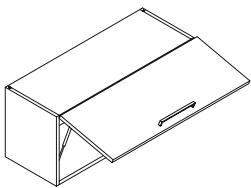

Product Code	Description	Dimensions (W x H x D)
QWSU6035	Wall Unit, 1 Lift Up Door	600 x 350 x 300mm
QWSU8035	Wall Unit, 1 Lift Up Door	800 x 350 x 300mm
QWSU9035	Wall Unit, 1 Lift Up Door	900 x 350 x 300mm

Remarks : Comes with 1 Gaspring

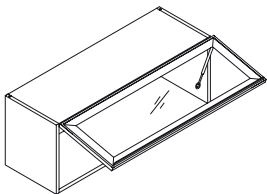

Product Code	Description	Dimensions (W x H x D)
QWAGSU6035	Wall Unit, 1 Lift Up Glass Door	600 x 350 x 300mm
QWAGSU8035	Wall Unit, 1 Lift Up Glass Door	800 x 350 x 300mm
QWAGSU9035	Wall Unit, 1 Lift Up Glass Door	900 x 350 x 300mm

Remarks : Comes with 1 Gaspring

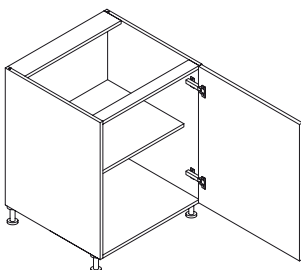

Product Code	Description	Dimensions (W x H x D)
QB3070	Base Unit, 1 Door, 1 Shelf	300 x 700 x 560mm
QB4070	Base Unit, 1 Door, 1 Shelf	400 x 700 x 560mm
QB4570	Base Unit, 1 Door, 1 Shelf	450 x 700 x 560mm
QB5070	Base Unit, 1 Door, 1 Shelf	500 x 700 x 560mm
QB6070	Base Unit, 1 Door, 1 Shelf	600 x 700 x 560mm

◆ Kitchen module

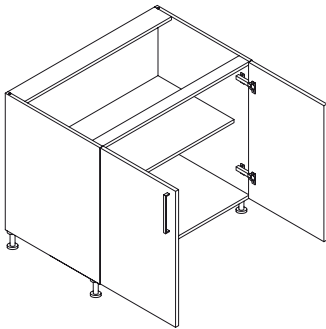

Product Code	Description	Dimensions (W x H x D)
QB8070	Base Unit, 2 Doors, 1 Shelf	800 x 700 x 560mm
QB9070	Base Unit, 2 Doors, 1 Shelf	900 x 700 x 560mm
QB10070	Base Unit, 2 Doors, 1 Shelf	1000 x 700 x 560mm
QB12070	Base Unit, 2 Doors, 1 Shelf	1200 x 700 x 560mm

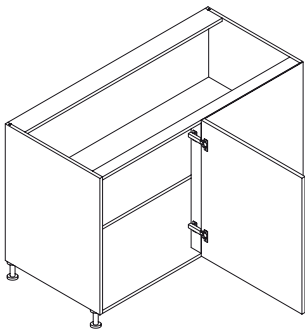

Product Code	Description	Dimensions (W x H x D)
QBC10070	Base Corner Unit, 1 Door (400mm), 1 Shelf	900 x 700 x 560mm (Void 100)
QBC10570	Base Corner Unit, 1 Door (450mm), 1 Shelf	900 x 700 x 560mm (Void 150)
QBC11070	Base Corner Unit, 1 Door (500mm), 1 Shelf	900 x 700 x 560mm (Void 200)
QBC12070	Base Corner Unit, 1 Door (600mm), 1 Shelf	1200 x 700 x 560mm

Remarks : Include 1 Infill

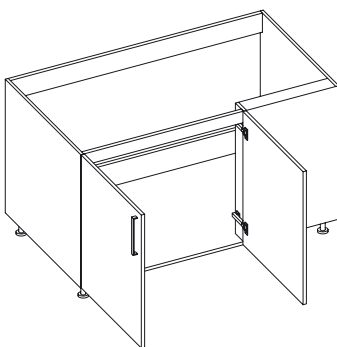

Product Code	Description	Dimensions (W x H x D)
QBCS14070	Base Corner Sink Unit, 2 Doors (400mm)	1400 x 700 x 560mm
QBCS15070	Base Corner Sink Unit, 2 Doors (450mm)	1400 x 700 x 560mm (Void 100)



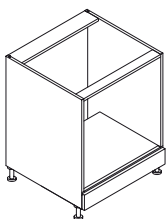

Remarks : Include 1 Infill



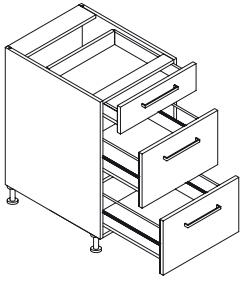

Product Code	Description	Dimensions (W x H x D)
QBB6070	Base Oven Unit, 1 Dummy Drawer	600 x 700 x 560mm

◆ Kitchen module



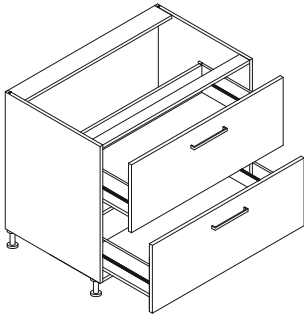



Product Code	Description	Dimensions (W x H x D)
QBD3S4570 	Drawer Unit, 3 Soft Close Drawers	450 x 700 x 560mm
QBD3S6070 	Drawer Unit, 3 Soft Close Drawers	600 x 700 x 560mm
<i>Remarks : Optibox</i>		
QBD3Q4570 	Drawer Unit, 3 Metal Box Drawers	450 x 700 x 560mm
QBD3Q6070 	Drawer Unit, 3 Metal Box Drawers	600 x 700 x 560mm
<i>Remarks : Metal Box</i>		

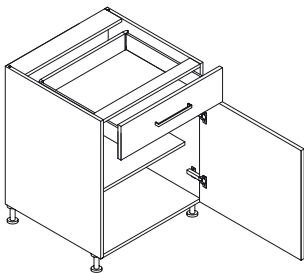

Product Code	Description	Dimensions (W x H x D)
QBD2S9070 	Drawer Unit, 2 Soft Close Drawers	900 x 700 x 560mm
<i>Remarks : Optibox</i>		
QBD2Q9070 	Drawer Unit, 2 Metal Box Drawers	900 x 700 x 560mm
<i>Remarks : Metal Box</i>		



Product Code	Description	Dimensions (W x H x D)
QBTDS4570 	Base Unit, 1 Door, 1 Soft Close Drawer	450 x 700 x 560mm
QBTDS6070 	Base Unit, 1 Door, 1 Soft Close Drawer	600 x 700 x 560mm
<i>Remarks : Optibox</i>		
QBTDAQ4570 	Base Unit, 1 Door, 1 Metal Box Drawer	450 x 700 x 560mm
QBTDAQ6070 	Base Unit, 1 Door, 1 Metal Box Drawer	600 x 700 x 560mm
<i>Remarks : Metal Box</i>		

◆ Kitchen module

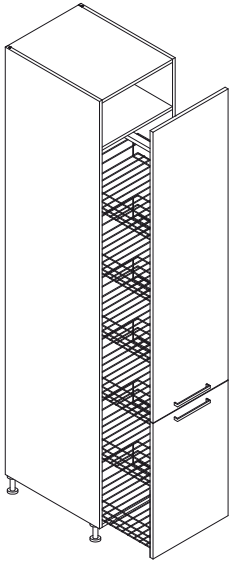

Product Code	Description	Dimensions (W x H x D)
QTE45200	Tall Larder Unit, 1 Joint Door (2pcs)	450 x 2000 x 560mm

Remarks : With larder basket (E4053)

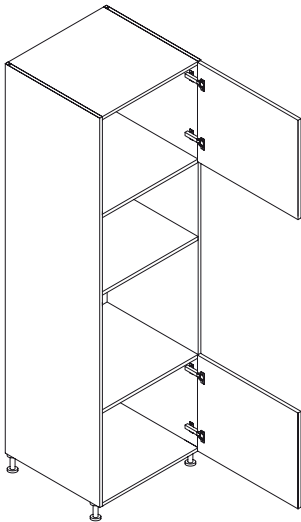

Product Code	Description	Dimensions (W x H x D)
QTOM60200	Tall Oven & Microwave Unit, 2 Doors	600 x 2000 x 560mm

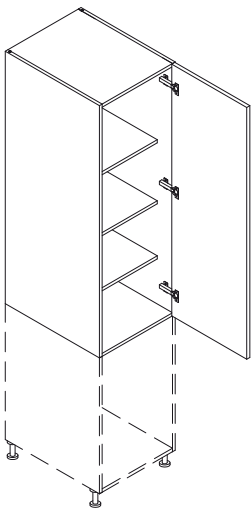

Product Code	Description	Dimensions (W x H x D)
QJ45130	Joint Unit, 1 Door, 3 Shelf	450 x 1300 x 560mm
QJ60130	Joint Unit, 1 Door, 3 Shelf	600 x 1300 x 560mm

◆ Kitchen module

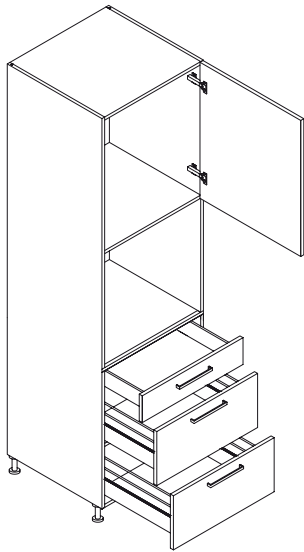

Product Code	Description	Dimensions (W x H x D)
--------------	-------------	------------------------

QTOD3S60200	 Oven Unit, 1 Door, 3 Soft Close Drawers	600 x 2000 x 560mm
-------------	--	--------------------

Remarks : Optibox

QTOD3Q60200	 Oven Unit, 1 Door, 3 Metal Box Drawers	600 x 2000 x 560mm
-------------	---	--------------------

Remarks : Metal Box

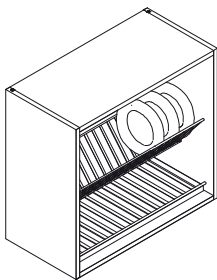

Product Code	Description	Dimensions (W x H x D)
--------------	-------------	------------------------

QWOSE6055	 Colour Carcass, for 600 Dish Rack	600 x 550 x 300mm
-----------	--	-------------------

QWOSE9055	 Colour Carcass, for 900 Dish Rack	900 x 550 x 300mm
-----------	--	-------------------

Remarks : Include dish rack

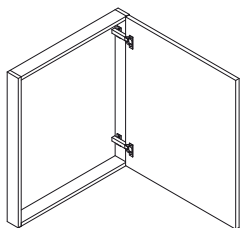

Product Code	Description	Dimensions (W x H)
--------------	-------------	--------------------

QDF3070	 1 Door & Frame	300 x 700mm
---------	--	-------------

QDF4070	 1 Door & Frame	400 x 700mm
---------	--	-------------

QDF4570	 1 Door & Frame	450 x 700mm
---------	--	-------------

QDF5070	 1 Door & Frame	500 x 700mm
---------	--	-------------

QDF6070	 1 Door & Frame	600 x 700mm
---------	--	-------------

QDF8070	 2 Doors & Frame	800 x 700mm
---------	---	-------------

QDF9070	 2 Doors & Frame	900 x 700mm
---------	---	-------------

QDF10070	 2 Doors & Frame	1000 x 700mm
----------	---	--------------

QDF12070	 2 Doors & Frame	1200 x 700mm
----------	---	--------------

Remarks : Install under concrete worktop without carcass

◆ Wardrobe **module**

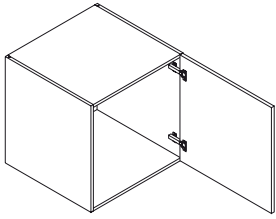

Product Code		Description	Dimensions (W x H x D)
QJ4560		Joint Unit, 1 Door	450 x 600 x 560mm
QJ6060		Joint Unit, 1 Door	600 x 600 x 560mm

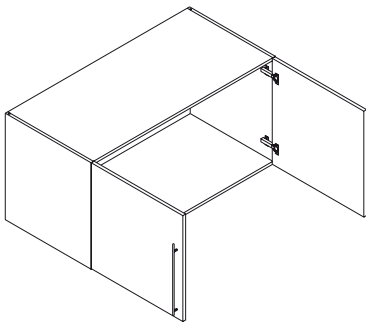

Product Code		Description	Dimensions (W x H x D)
QJ9060		Joint Unit, 2 Doors	900 x 600 x 560mm
QJ12060		Joint Unit, 2 Doors	1200 x 600 x 560mm

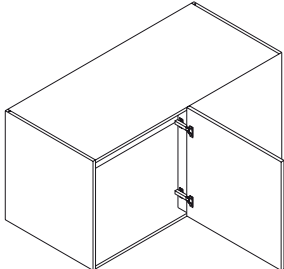

Product Code		Description	Dimensions (W x H x D)
QJC10560		Joint Corner Unit, 1 Door (450mm)	900 x 600 x 560mm (Void 150)
QJC12060		Joint Corner Unit, 1 Door (600mm)	1200 x 600 x 560mm

Remarks : Include 1 Infill

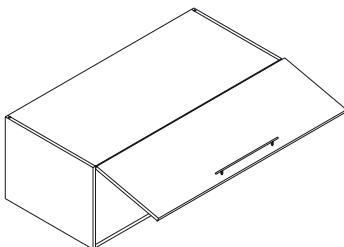

Product Code		Description	Dimensions (W x H x D)
QJSU7545		Joint Unit, Flip Up Door	750 x 450 x 560mm
QJSU9045		Joint Unit, Flip Up Door	900 x 450 x 560mm
QJSU10545		Joint Unit, Flip Up Door	1050 x 450 x 560mm
QJSU12045		Joint Unit, Flip Up Door	1200 x 450 x 560mm
QJSU13545		Joint Unit, Flip Up Door	1350 x 450 x 560mm
QJSU16545		Joint Unit, Flip Up Door	1650 x 450 x 560mm

Remarks : Comes with 2 Gaspring

◆ Wardrobe module

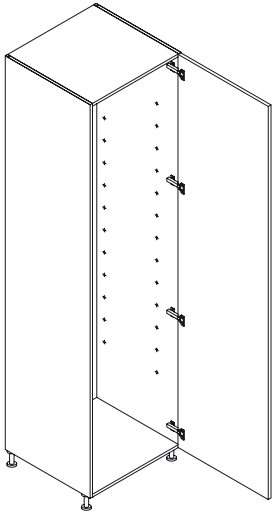

Product Code		Description	Dimensions (W x H x D)
QT45225		Tall Unit, 1 Door	450 x 2250 x 560mm
QT60225		Tall Unit, 1 Door	600 x 2250 x 560mm

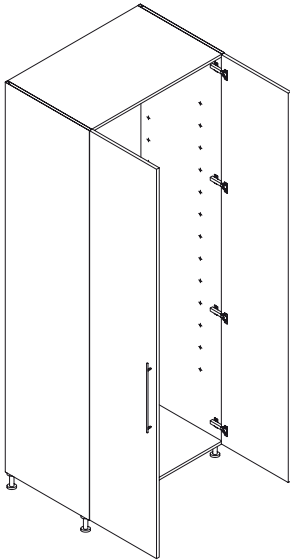

Product Code		Description	Dimensions (W x H x D)
QT90225		Tall Unit, 2 Doors	900 x 2250 x 560mm
QT120225		Tall Unit, 2 Doors	1200 x 2250 x 560mm

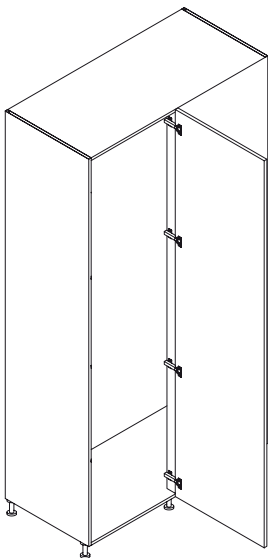

Product Code		Description	Dimensions (W x H x D)
QTC105225		Tall Corner Unit, 1 Door (450mm)	900 x 2250 x 560mm (Void 150)
QTC120225		Tall Corner Unit, 1 Door (600mm)	1200 x 2250 x 560mm

Remarks : Include 1 Infill

◆ Wardrobe carcass (sliding system)

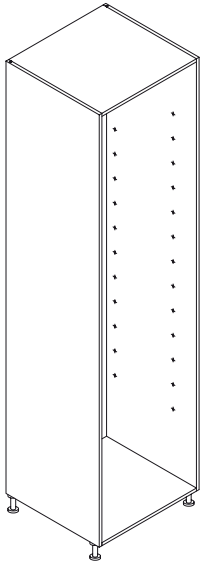

Product Code		Description	Dimensions (W x H x D)
T45225F		Tall Carcass	450 x 2250 x 560mm
T60225F		Tall Carcass	600 x 2250 x 560mm
T75225F		Tall Carcass	750 x 2250 x 560mm
T90225F		Tall Carcass	900 x 2250 x 560mm
T105225F		Tall Carcass	1050 x 2250 x 560mm
T120225F		Tall Carcass	1200 x 2250 x 560mm

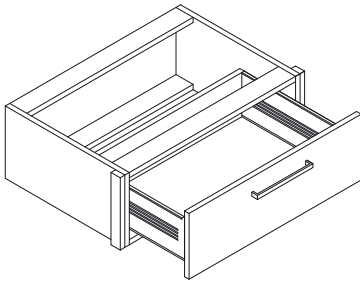

Product Code		Description	Dimensions (W x H x D)
D4522		Wardrobe Internal Drawer	417 x 220 x 420mm
D6022		Wardrobe Internal Drawer	567 x 220 x 420mm

◆ Wardrobe sliding door



Product Code	Description	Dimensions (W x H)
QSL2FG-150	2 x Sliding FG Doors c/w Roller, Track & Guide	1500 x 2250mm
QSL2FG-180	2 x Sliding FG Doors c/w Roller, Track & Guide	1800 x 2250mm
QSL2FG-210	2 x Sliding FG Doors c/w Roller, Track & Guide	2100 x 2250mm
QSL2FG-240	2 x Sliding FG Doors c/w Roller, Track & Guide	2400 x 2250mm

Remarks : Frosted glass sliding door only, exclude carcass



Product Code	Description	Dimensions (W x H)
QSL3FG-270	3 x Sliding FG Doors c/w Roller, Track & Guide	2700 x 2250mm
QSL3FG-315	3 x Sliding FG Doors c/w Roller, Track & Guide	3150 x 2250mm
QSL3FG-360	3 x Sliding FG Doors c/w Roller, Track & Guide	3600 x 2250mm

Remarks : Frosted glass sliding door only, exclude carcass



Product Code	Description	Dimensions (W x H)
QSL2MR-150	2 x Sliding MR Doors c/w Roller, Track & Guide	1500 x 2250mm
QSL2MR-180	2 x Sliding MR Doors c/w Roller, Track & Guide	1800 x 2250mm
QSL2MR-210	2 x Sliding MR Doors c/w Roller, Track & Guide	2100 x 2250mm
QSL2MR-240	2 x Sliding MR Doors c/w Roller, Track & Guide	2400 x 2250mm

Remarks : Mirror sliding door only, exclude carcass

◆ Wardrobe sliding door



Product Code	Description	Dimensions (W x H)
QSL3MR-270	3 x Sliding MR Doors c/w Roller, Track & Guide	2700 x 2250mm
QSL3MR-315	3 x Sliding MR Doors c/w Roller, Track & Guide	3150 x 2250mm
QSL3MR-360	3 x Sliding MR Doors c/w Roller, Track & Guide	3600 x 2250mm

Remarks : Mirror sliding door only, exclude carcass



Product Code	Description	Dimensions (W x H)
QSL2MFC-150	2 x Sliding MFC Doors c/w Roller, Track & Guide	1500 x 2250mm
QSL2MFC-180	2 x Sliding MFC Doors c/w Roller, Track & Guide	1800 x 2250mm
QSL2MFC-210	2 x Sliding MFC Doors c/w Roller, Track & Guide	2100 x 2250mm
QSL2MFC-240	2 x Sliding MFC Doors c/w Roller, Track & Guide	2400 x 2250mm

Remarks : MFC panel sliding door, exclude carcass



Product Code	Description	Dimensions (W x H)
QSL3MFC-270	3 x Sliding MFC Doors c/w Roller, Track & Guide	2700 x 2250mm
QSL3MFC-315	3 x Sliding MFC Doors c/w Roller, Track & Guide	3150 x 2250mm
QSL3MFC-360	3 x Sliding MFC Doors c/w Roller, Track & Guide	3600 x 2250mm

Remarks : MFC panel sliding door, exclude carcass

◆ Wardrobe **extra component**



Product Code		Description	Dimensions (W x L)
16JEP6860		End Panel	680 x 600mm
16TEP68242		End Panel	680 x 2420mm



Product Code		Description	Dimensions (W x L)
DIF1570		Infill	150 x 700mm
DIF15240		Infill	150 x 2400mm



Product Code		Description	Dimensions (W x L)
PLP12244		Plinth	120 x 2440mm

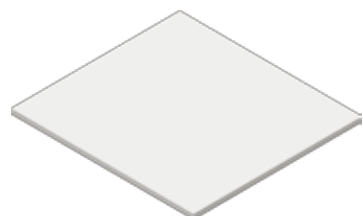

Product Code		Description	Dimensions (W x L)
16AS4545		Adjustable Shelf	417 x 450mm
16AS4560		Adjustable Shelf	567 x 450mm
16AS4575		Adjustable Shelf	717 x 450mm
16AS4590		Adjustable Shelf	867 x 450mm
16AS45105		Adjustable Shelf	1017 x 450mm
16AS45120		Adjustable Shelf	1167 x 450mm

◆ Kitchen **extra component**



Product Code	Description	Dimensions (W x L)
WEP3270	Wall Unit End Panel	320 x 700mm
WEP3235	Wall Unit End Panel	320 x 350mm
BEP6070	Base Unit End Panel	600 x 700mm
TEP60200	Tall Unit End Panel	600 x 2000mm



Product Code	Description	Dimensions (W x L)
DIF1570	Infill Panel	150 x 700mm
DIF15240	Infill Panel	150 x 2400mm



Product Code	Description	Dimensions (W x L)
DP9070	Island Décor Panel	900 x 700mm
DP12070	Island Décor Panel	1200 x 700mm
DP15070	Island Décor Panel	1500 x 700mm
DP18070	Island Décor Panel	1800 x 700mm





Product Code	Description	Dimensions (W x L)
FOP32120	Flyover Panel	320 x 1200mm
LE32240	Flyover Panel	320 x 2440mm

◆ Accessories for kitchen



Product Code

SAO867 
 Alum Sink Bottom for 900 Module

SAO1167 
 Alum Sink Bottom for 1200 Module

U.O.M : Pcs



Product Code

ESC45 
 S.Steel Cutlery Tray 450 Module

ESC60 
 S.Steel Cutlery Tray 600 Module

U.O.M : Set



Product Code

C450 
 PVC Cutlery Tray 450 Module

C600 
 PVC Cutlery Tray 600 Module

U.O.M : Pcs



Product Code

T3101 
 Pull Out Waste Bin for 300 Module

U.O.M : Unit



Product Code

SW810-MR 
 Aluminium Wallseal x Meter Run

U.O.M : MR



Product Code

B50NY 
 Surface Mounted LED Eyeball

P1.15W-MAX 
 LED Driver With Switch

U.O.M : Pcs



Product Code

WSCAP-LR 
 Wallseal End Cap L/R

U.O.M : Pair

WSCAP-I 
 Wallseal Internal Cap

WSCAP-E 
 Wallseal External Cap

U.O.M : Pcs





Product Code

ALUC-150 
 PVC Plinth Corner Cap H150

U.O.M : Pcs

Product Code

PLA15-MR 
 Alu PVC Plinth 150H x Meter Run

PLA10-MR 
 Alu PVC Plinth 100H x Meter Run

U.O.M : MR

◆ Accessories for kitchen



Product Code

K603M



Ducknose Holder

U.O.M : Pair



Product Code

WESCO



Swing Out Waste Bin

U.O.M : Unit



Product Code

E4301



Etica Side Mounted Pull-Out for 300 Module

U.O.M : Set



Product Code

E4501



E4503



E4506



Etica Base Pull-Out for 450/600/900 Module

U.O.M : Pair



Product Code

E4101



Etica 180 Corner Swivel Basket

U.O.M : Set



Product Code

FL6.2060DG



Décor Glass Shelf 6 x 200 x 600

FL6.2090DG



Décor Glass Shelf 6 x 200 x 900

FL6.20120DG



Décor Glass Shelf 6 x 200 x 1200

U.O.M : Pcs



Product Code

E4053



Etica Tall Larder for 450 Module

U.O.M : Set

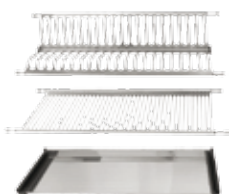

Product Code

PDR600



PDR900



S.Steel Dish Rack for 600/900 Module

U.O.M : Set

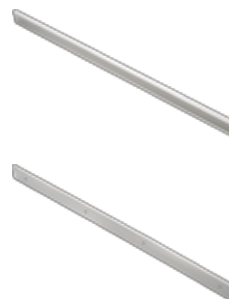

Product Code

AP819



T-Joint for HPL Top

T2978



T-Joint for Egger Top

U.O.M : Pcs

◆ Accessories for wardrobe

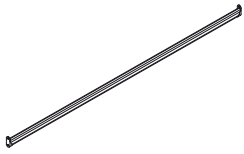



Product Code

ROD45 
Aluminium Rod 410mm

ROD60 
Aluminium Rod 560mm

ROD75 
Aluminium Rod 710mm

ROD90 
Aluminium Rod 860mm

ROD105 
Aluminium Rod 1010mm

ROD120 
Aluminium Rod 1160mm

U.O.M : Pcs



Product Code

E450W 
White Easy Basket for 450 module

E600W 
White Easy Basket for 600 module

U.O.M : Pcs



Product Code

SLMR 
Slide Out Mirror

U.O.M : Pcs

Product Code



RIMLOCK 
Rimlock c/w L Bracket

U.O.M : Pcs



◆ Door handles

Product Code		Product Code	
			
HD117.96CR		HD613.96CR	
			
HD4103.160AL		HD4203.160AL	
			
HD4206.160AL		HD7290.160AL	
			
HD743.192AL		HD5808.160AL	
			
HD2303.128SN		HD1602.128SN	
			
HD1203.160SN		HD308.256SN	
			
NA1630.296		NA1930.296	
NA1630.396		NA1930.396	
NA1630.446		NA1930.446	
NA1630.496		NA1930.496	
NA1630.596		NA1930.596	
NA1630.796		NA1930.796	
NA1630.896		NA1930.896	

◆ Kubiq's franchise business opportunity



With Kubiq, everyone can be a business owner!

Are you interested to join the **Kubiq Franchise Network**? This is the most easy to start and affordable business in the kitchen and wardrobe system industry.

- **LOW START-UP COST** - A profitable franchise business does not mean only a few can afford it.
- **LOW OVERHEAD** - Build a big business with little resources! Don't pay for a massive warehouse and high monthly operational costs – a Kubiq Kiosk only needs 100 square feet of space and you only pay salaries for yourself and an additional employeee.
- **TARGETED TO THE MASSES** - Kubiq products are designed for a mass market and you can expect to reap the benefits of high-volume revenues in a timely and visible manner.
- **EASY TO OPERATE** - You don't have to be an expert in the kitchen industry. Instead, rely on our experience of nearly 20 years where we have simplified the entire process and created simple tools that everybody can understand and use.
- **FAST TURN-AROUND TIME** - Instead of spending months following up on an order like any other conventional full-service kitchen provider, the Kubiq concept allows you to conclude an order within a day.
- **LOW CAPITAL OUTLAY** - You don't have to worry about stock purchases and warehousing. All you need is only to pay for material after customers have made an order.



The **Kubiq Kiosk** is a complete business tool to help every entrepreneur in selling the kitchen & wardrobe systems to any homeowner out there!

Need a helping hand?

If you need a little extra help, our professional services are right at your fingertips.



DELIVERY SERVICE

Need help getting your purchases home? At Kubiq, we keep our prices low by excluding delivery from the price of your cabinets. However, arranging prompt delivery at reasonable rates with us is as easy as 1-2-3. Check with our Logistic Partner for rates and delivery times.



INSTALLATION SERVICE

Kubiq's self-involvement concept puts you in control of your own hands-on installation. However, if you would rather trust a professional, we will put you in touch with our team of Registered Installers.



MEASURING SERVICE

For those who do not want to leave anything to chance, Kubiq also provides a measuring service for your kitchen. Check with our team of Registered Installers for rates and further details.



OTHER M&E SERVICES

Electrical, plumbing and ducting services are also available from our recommended contractor.